

# Cyathlon

## Benchmarking Assistive Devices

Dario Floreano, EPF Lausanne &  
Robert Riener, ETH Zurich





40'000 Amputations per Year (USA)

1.7 Million Amputees (USA)



60'000 C-Legs sold till 2015

C-Leg  
Otto  
Bock





# Common Prostheses Are Not Actuated

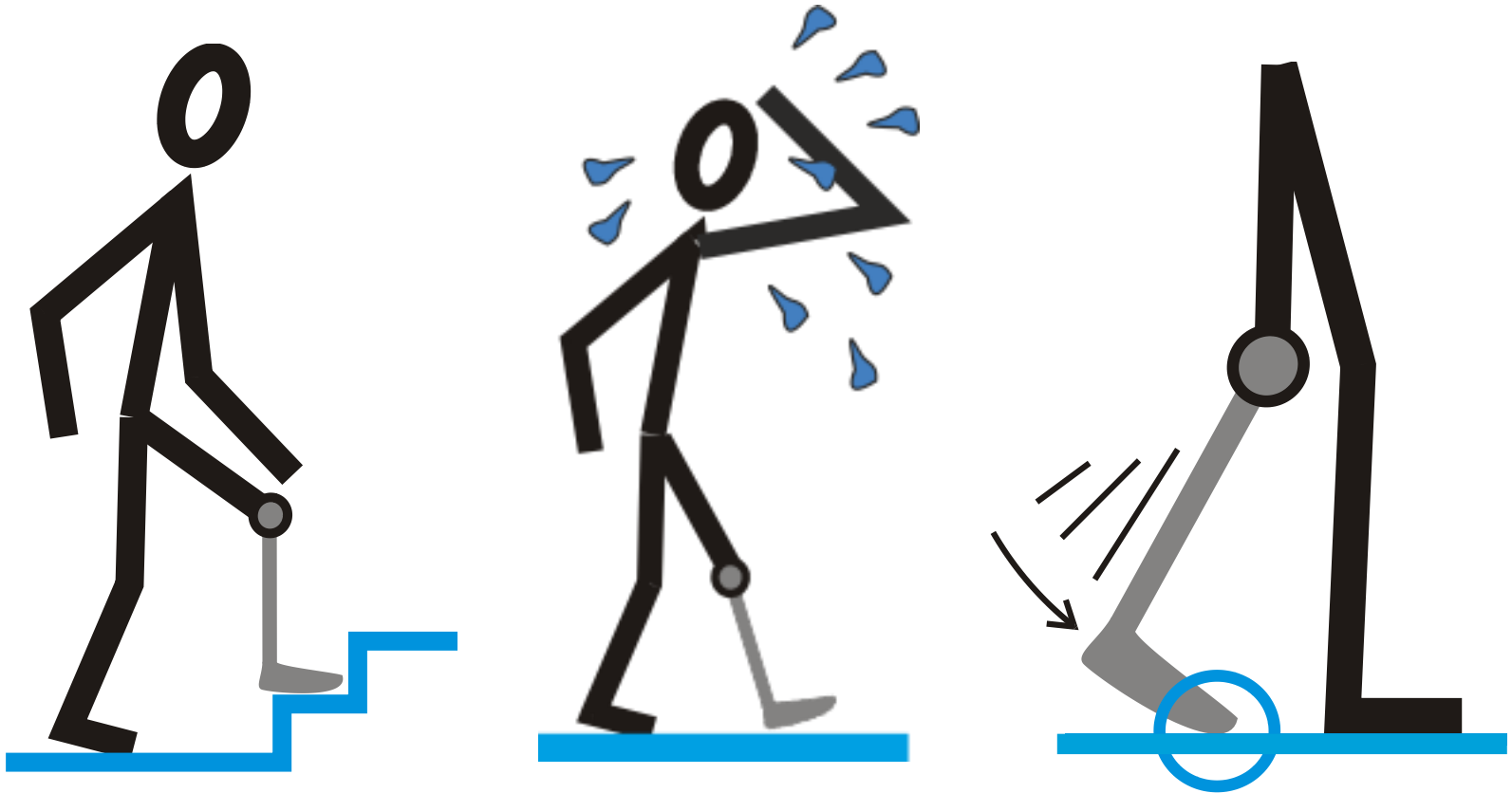



SKYRISE CHICAGO  
103<sup>RD</sup> FLOOR!



# 65 Million Wheelchair Users Worldwide<sup>1</sup>

<sup>1</sup>World Health Organization. *Guidelines on the Provision of Manual Wheelchairs*. WHO Press, 2008.



# Worldwide 500'000 New Cases of Spinal Cord Injury per Year<sup>1</sup>

<sup>1</sup>World Health Organization. *Spinal Cord Injury*. WHO Press, 2013.

© Tuesday 8 May 2012 09.35 EDT

## Paralysed Claire Lomas finishes London Marathon 16 days after it began

32-year-old is greeted by crowds of supporters as she becomes first to finish marathon in bionic suit







«Walk Again» Project, M, Nicoletis et al. FIFA World Cup 2014



# Cyathlon:

Promote the Development of  
USEFUL Assistive Systems ...



## ... and Remove Barriers

People with  
Disabilities



Research and  
Development

General Public



# Swiss Arena, Kloten, Zurich



# Muscle Stimulation Bike Race

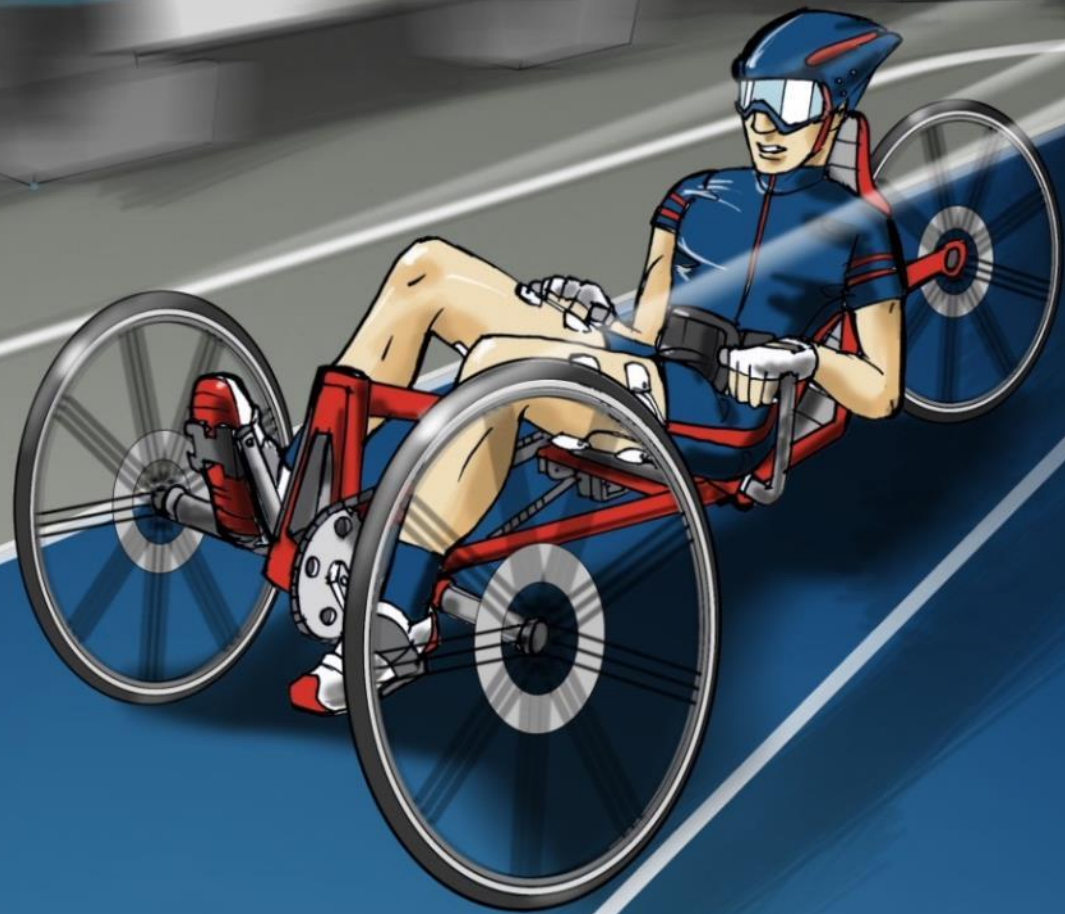



# Muscle Stimulation Bike Race

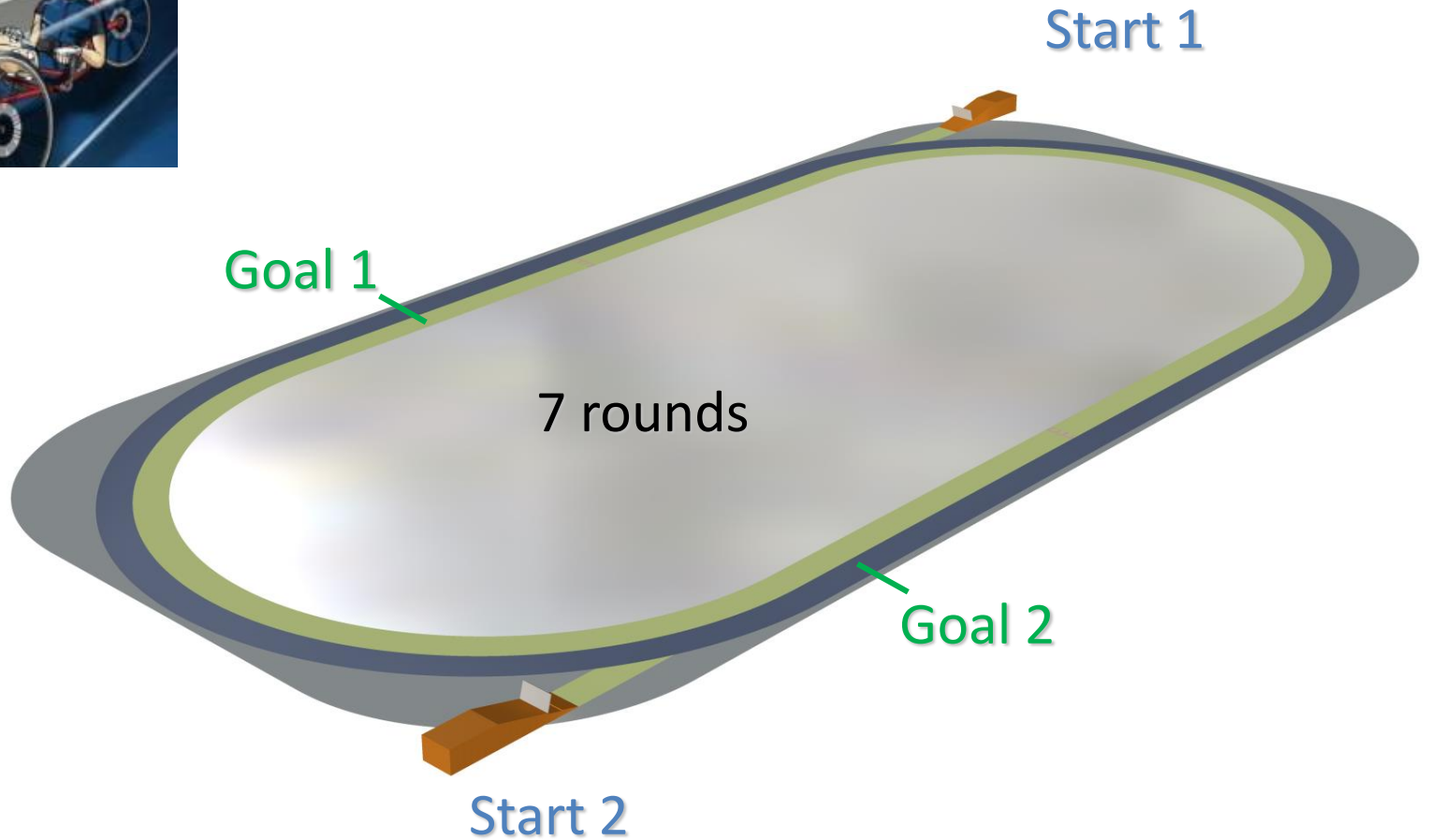









# Powered Exoskeleton Race

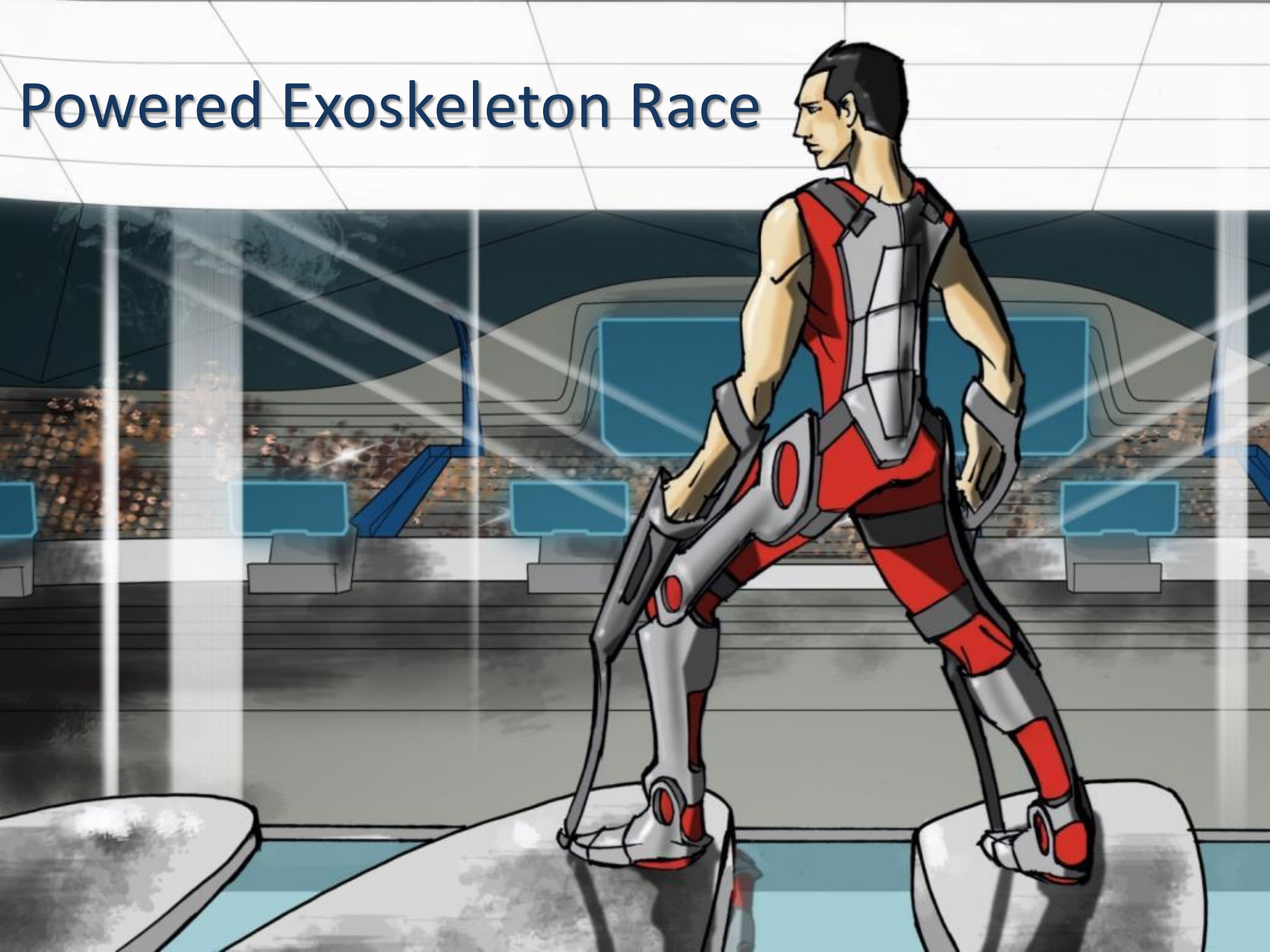



# Powered Exoskeleton Race

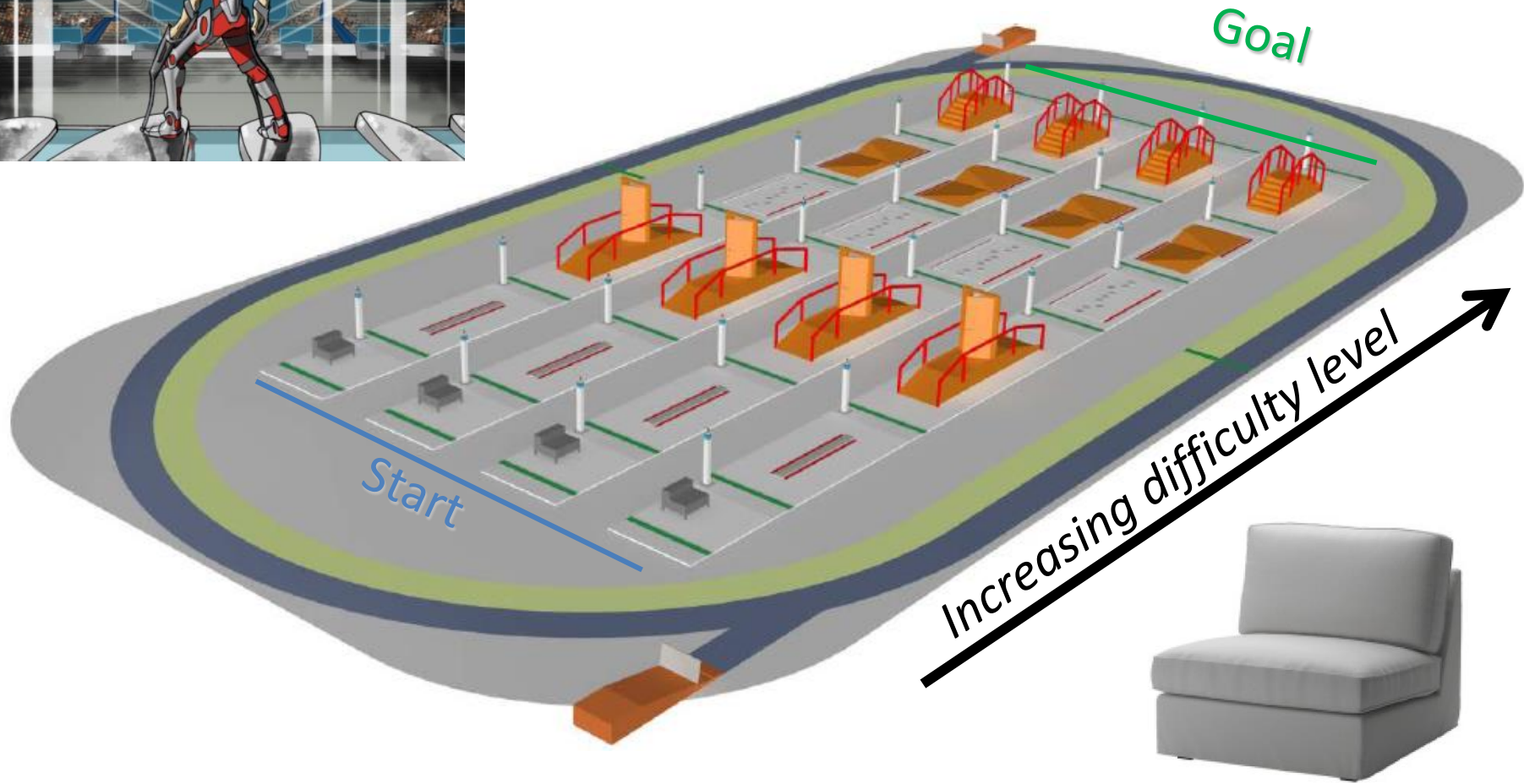



# Powered Exoskeleton Race

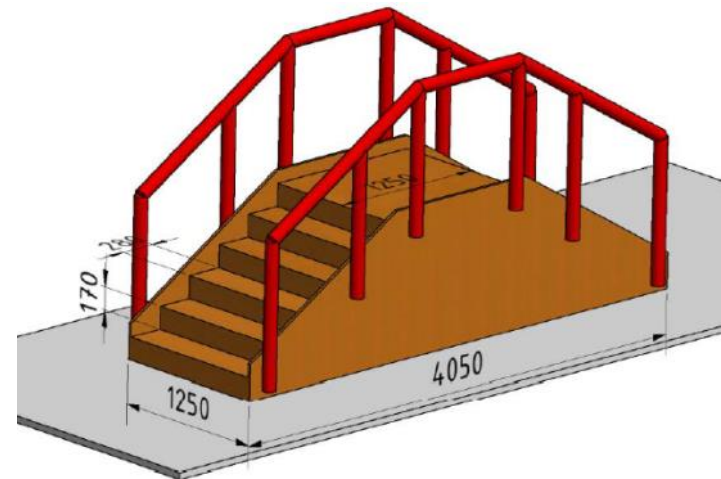
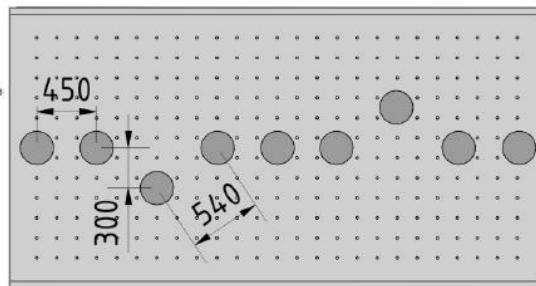
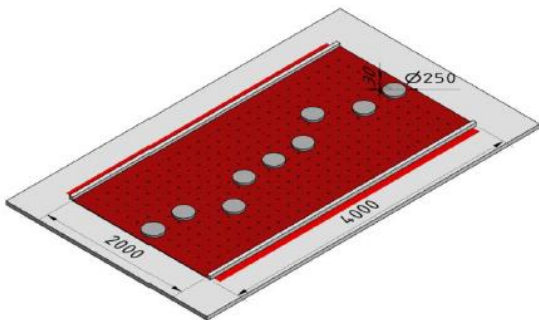
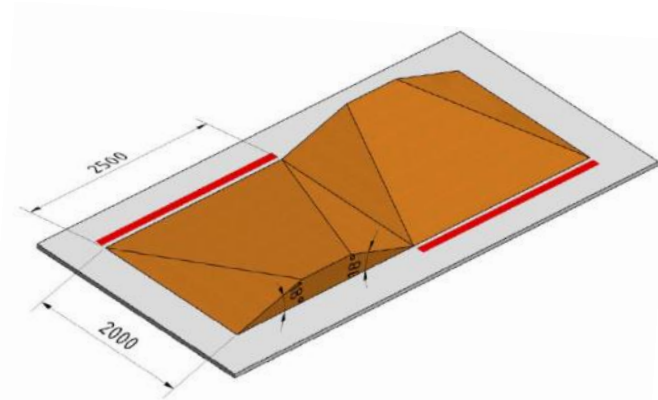
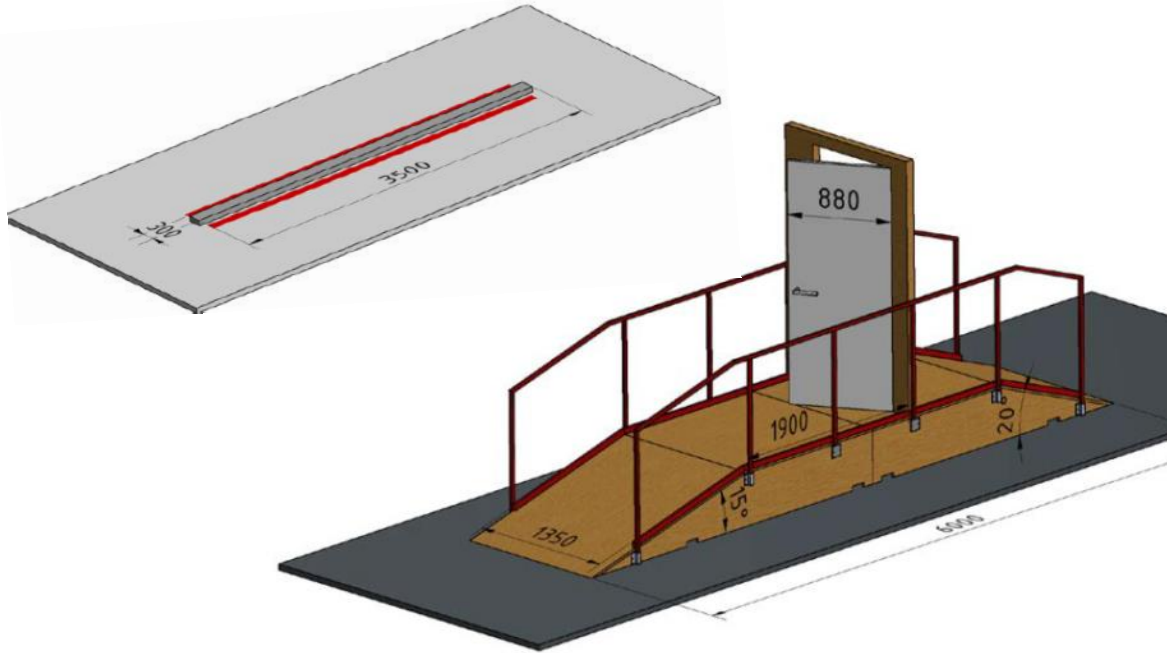





# Powered Leg Prosthesis Race



# Powered Prosthesis Race

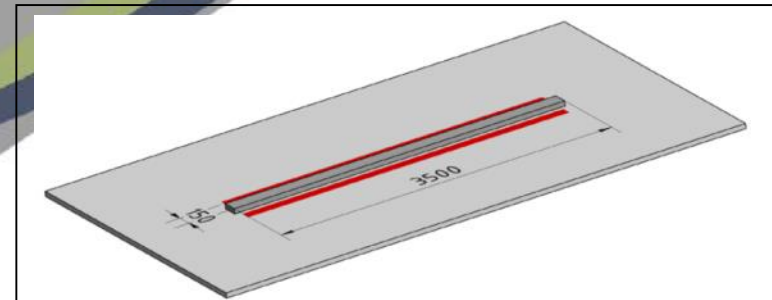
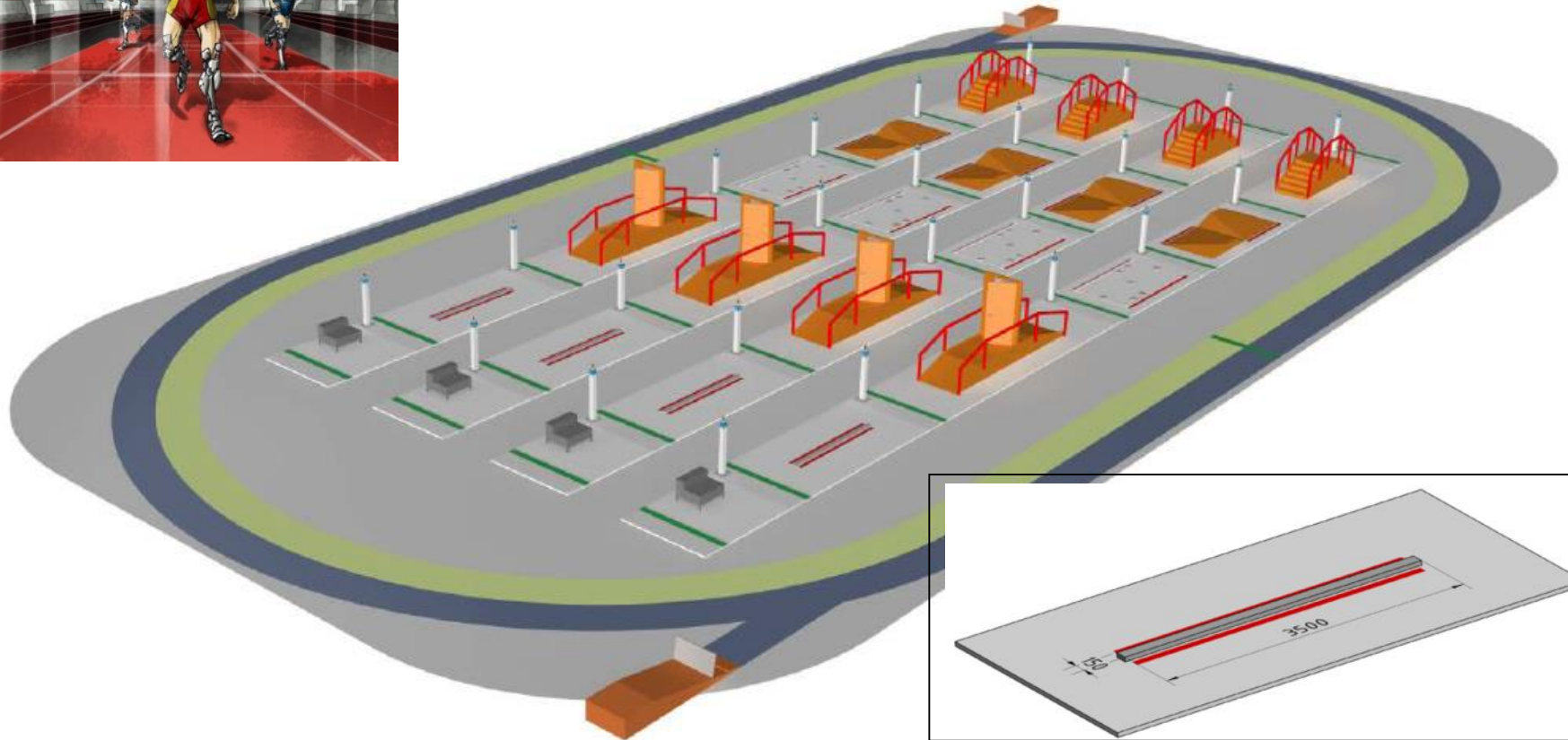







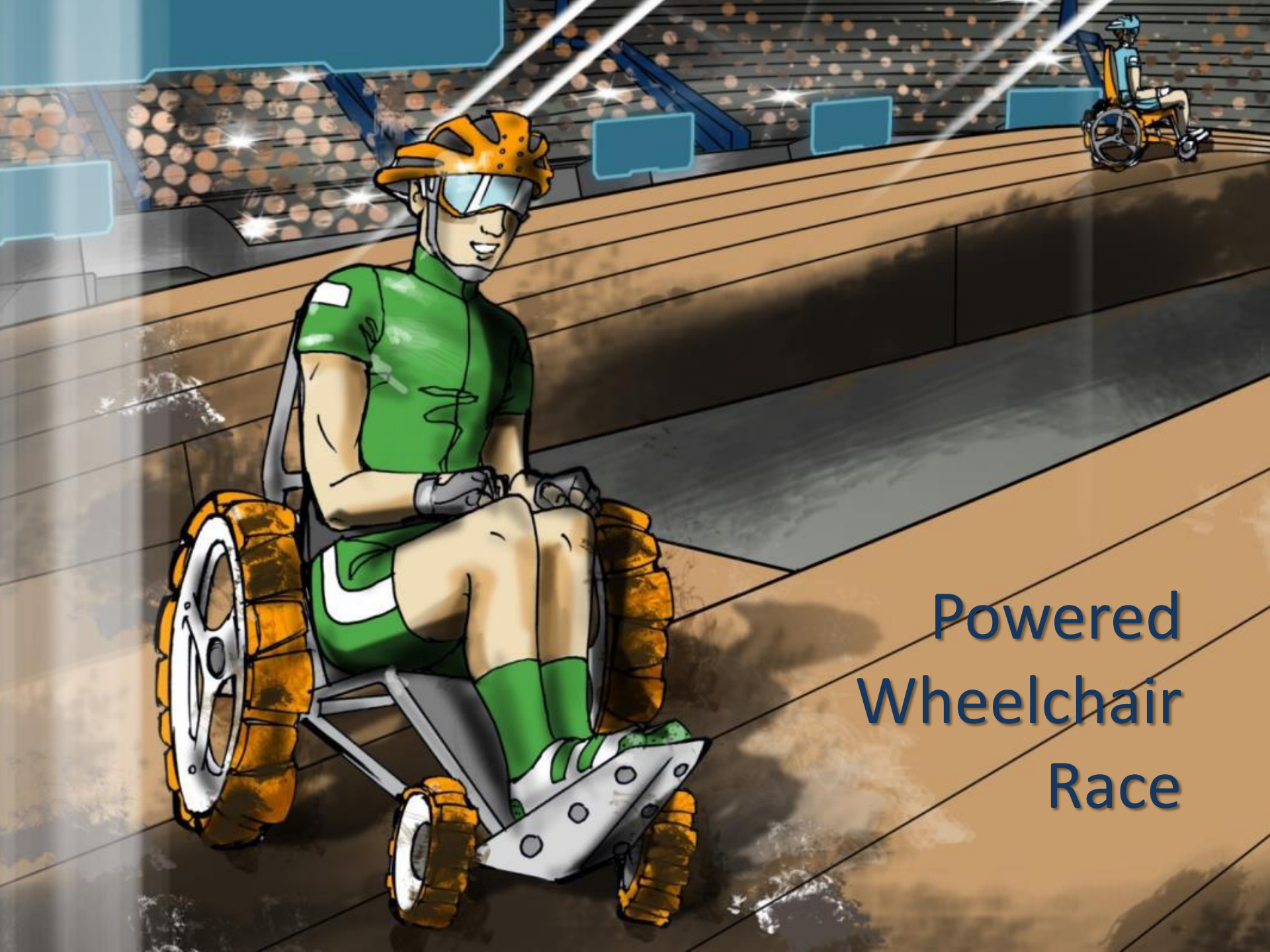

Powered  
Wheelchair  
Race



# Powered Wheelchair Race

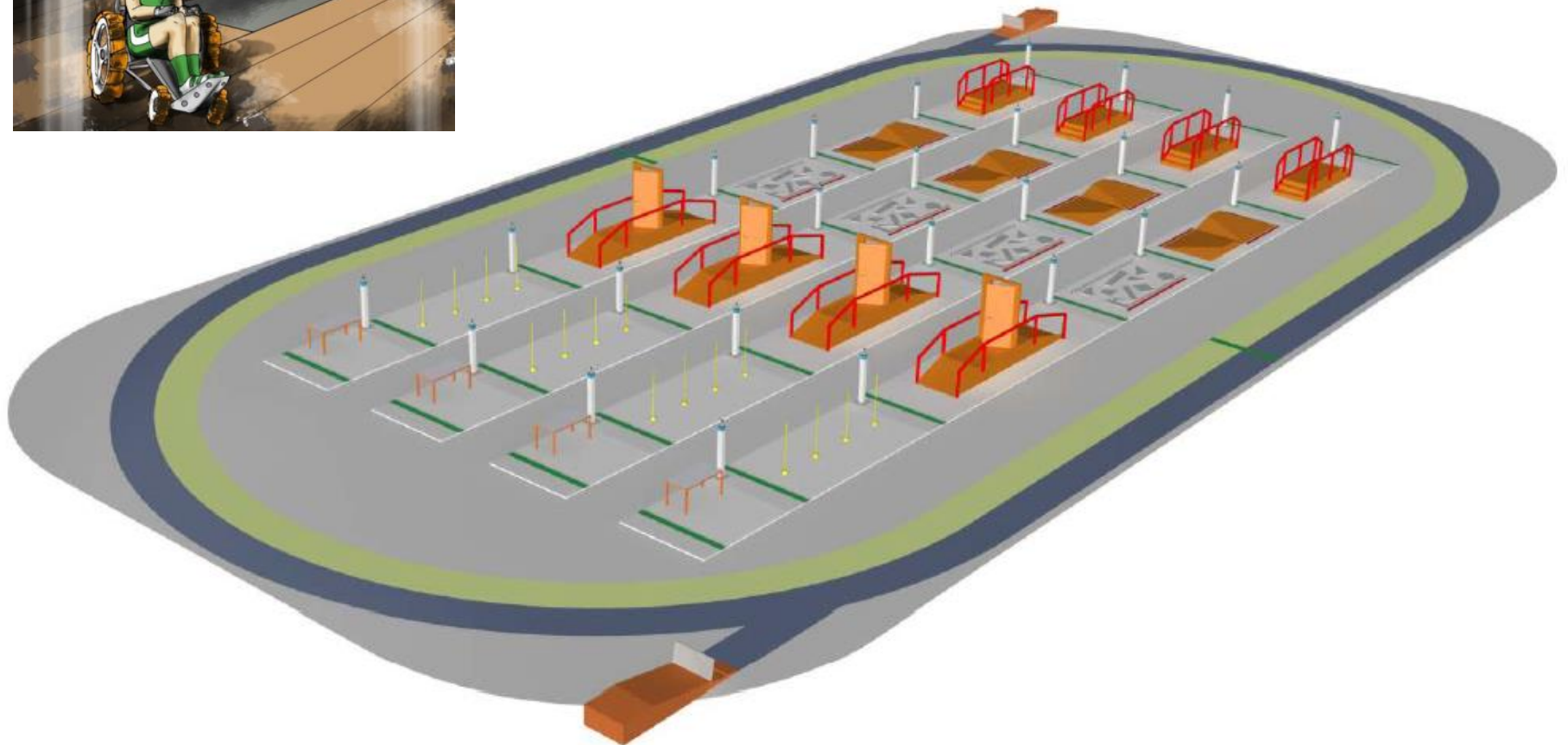



# Powered Wheelchair Race

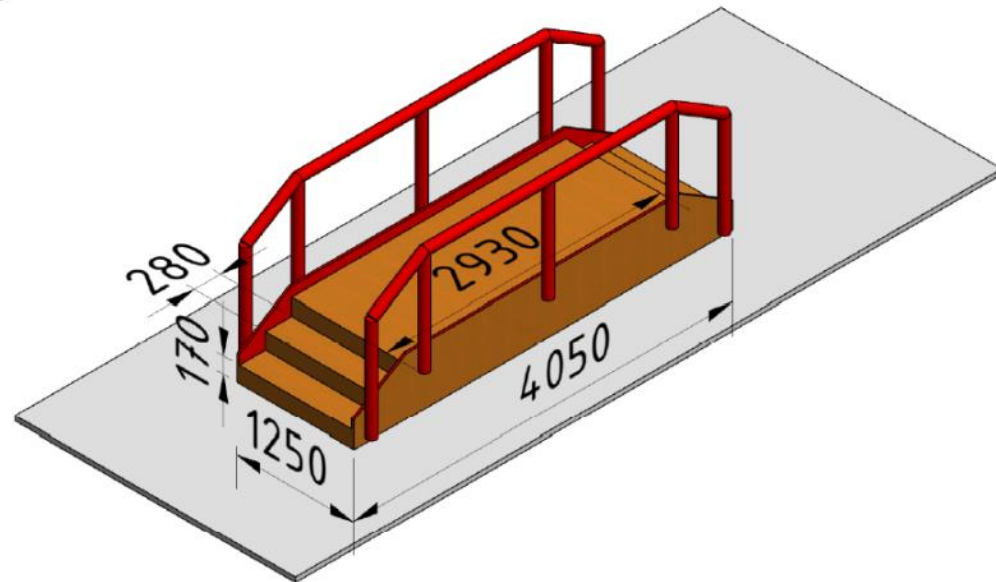
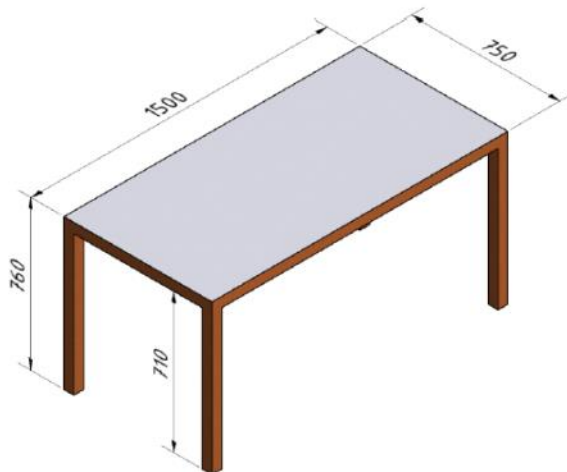
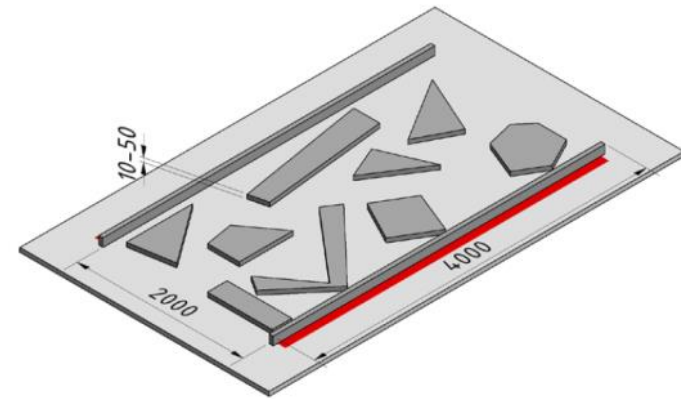
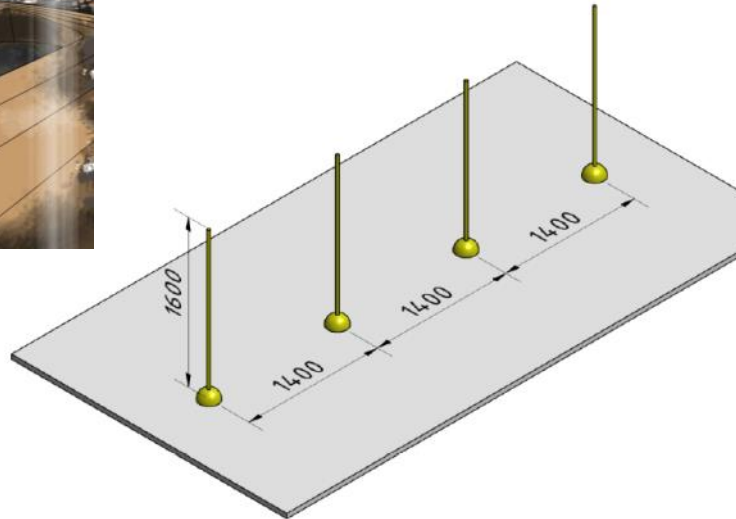







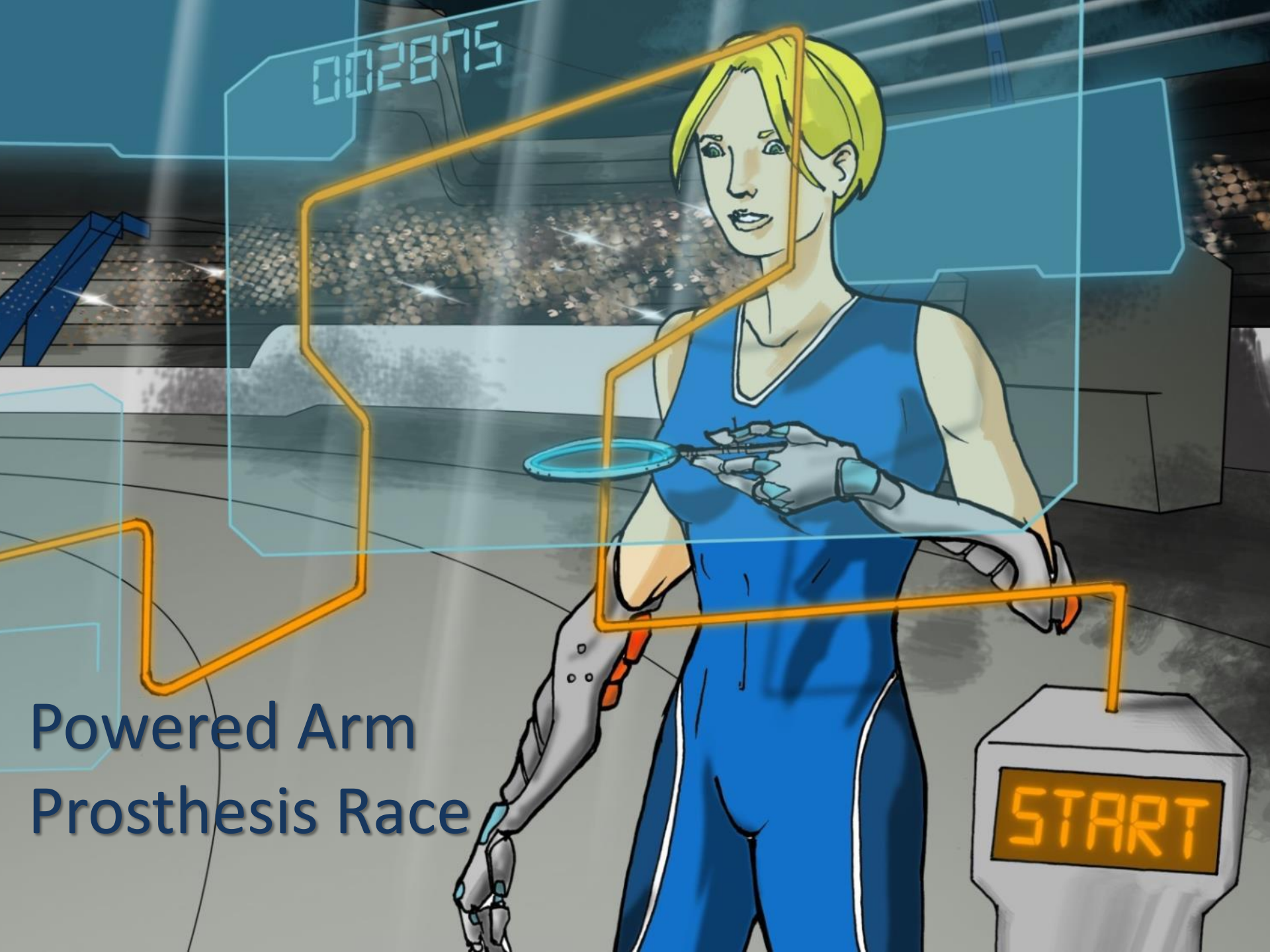

002875

# Powered Arm Prosthesis Race

START





# Powered Arm Prosthesis Race

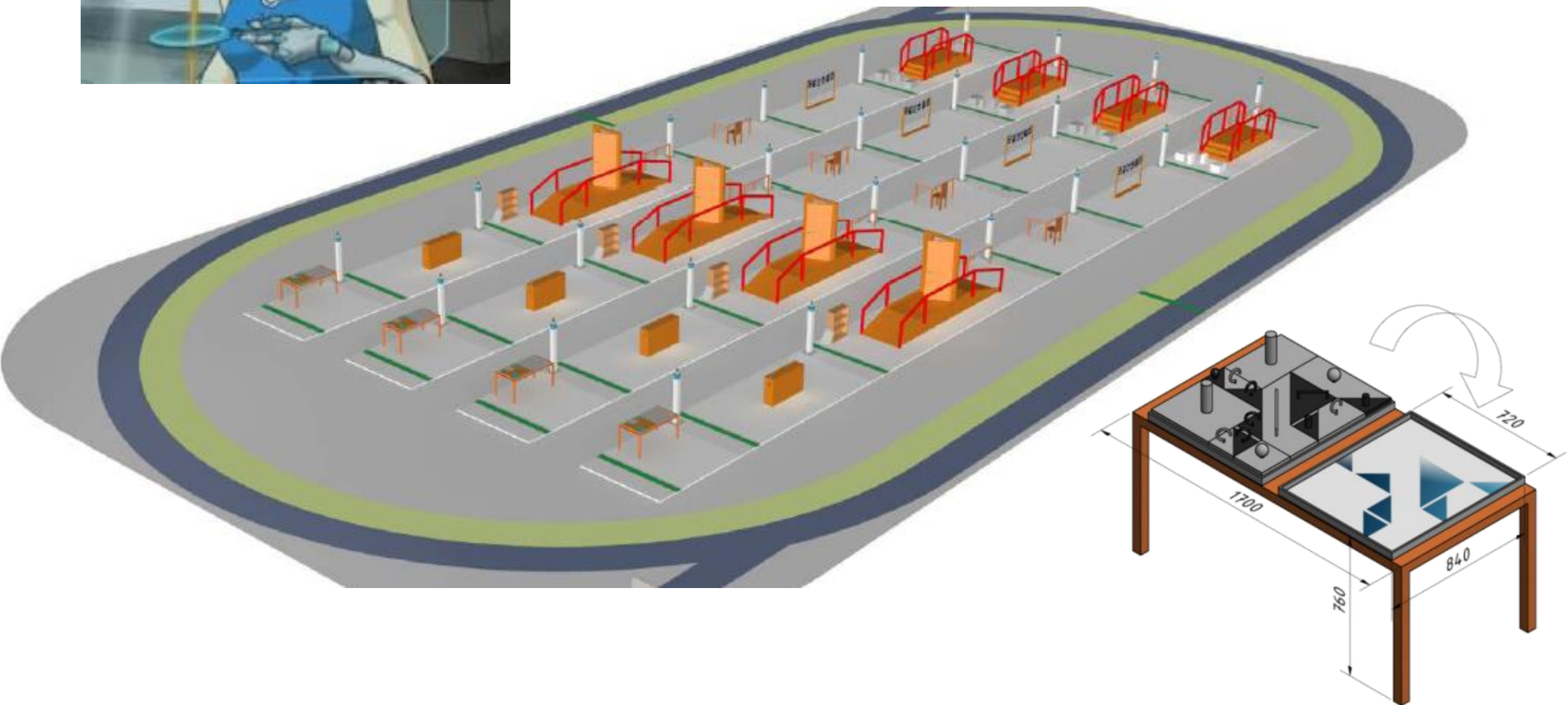



# Powered Arm Prosthesis Race

## Performance Tasks

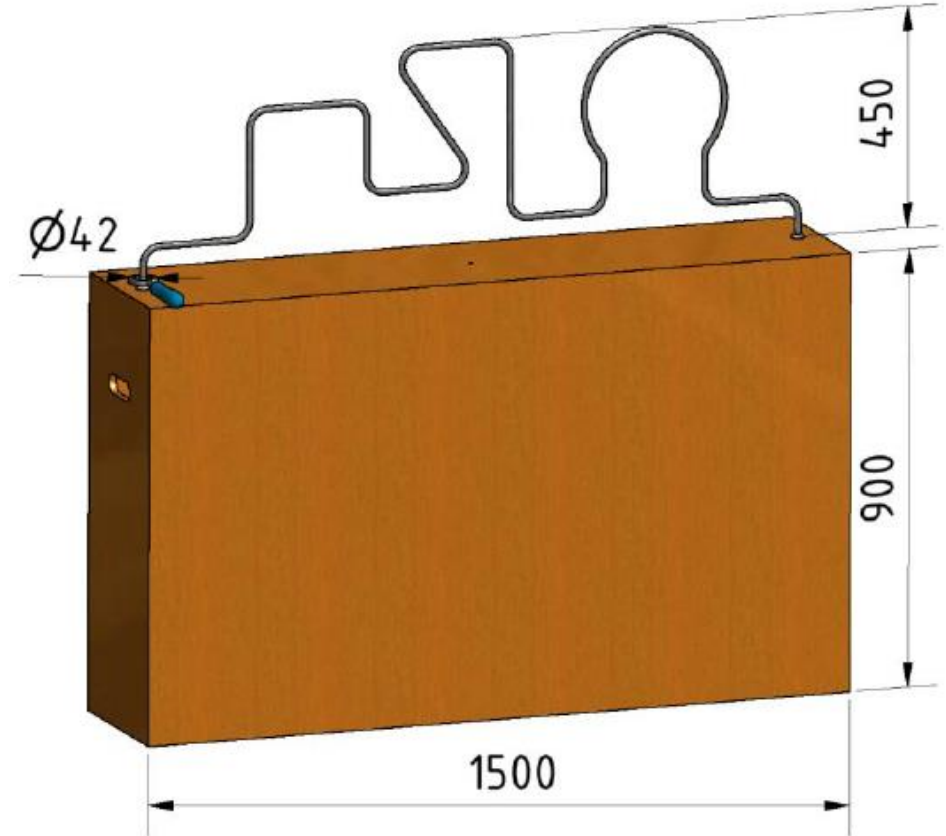
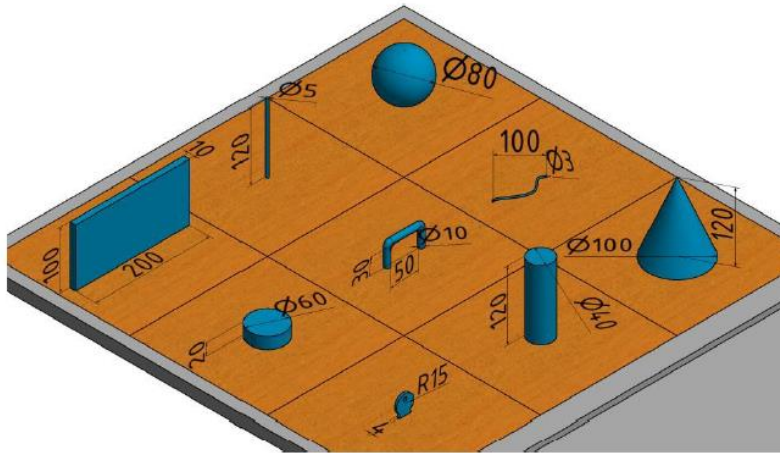



# Powered Arm Prosthesis Race



Activities of daily living tasks:  
Carry shopping bags and boxes

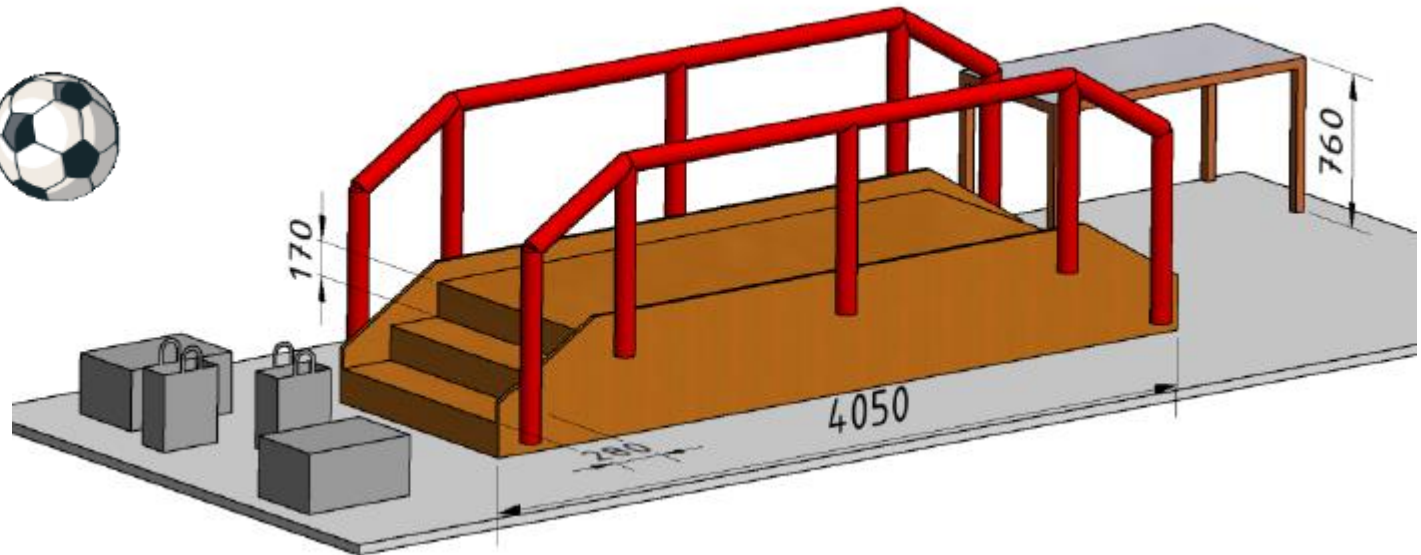



# Powered Arm Prosthesis Race



Activities of Daily Living Tasks:  
Prepare Breakfast on Table

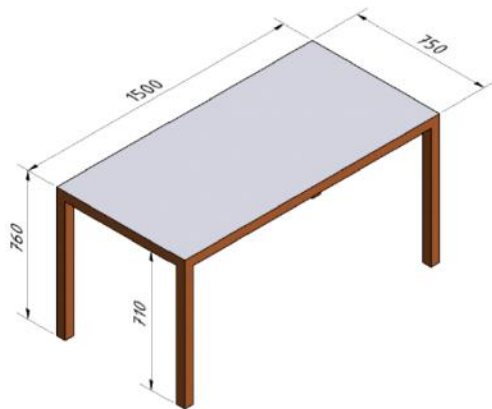

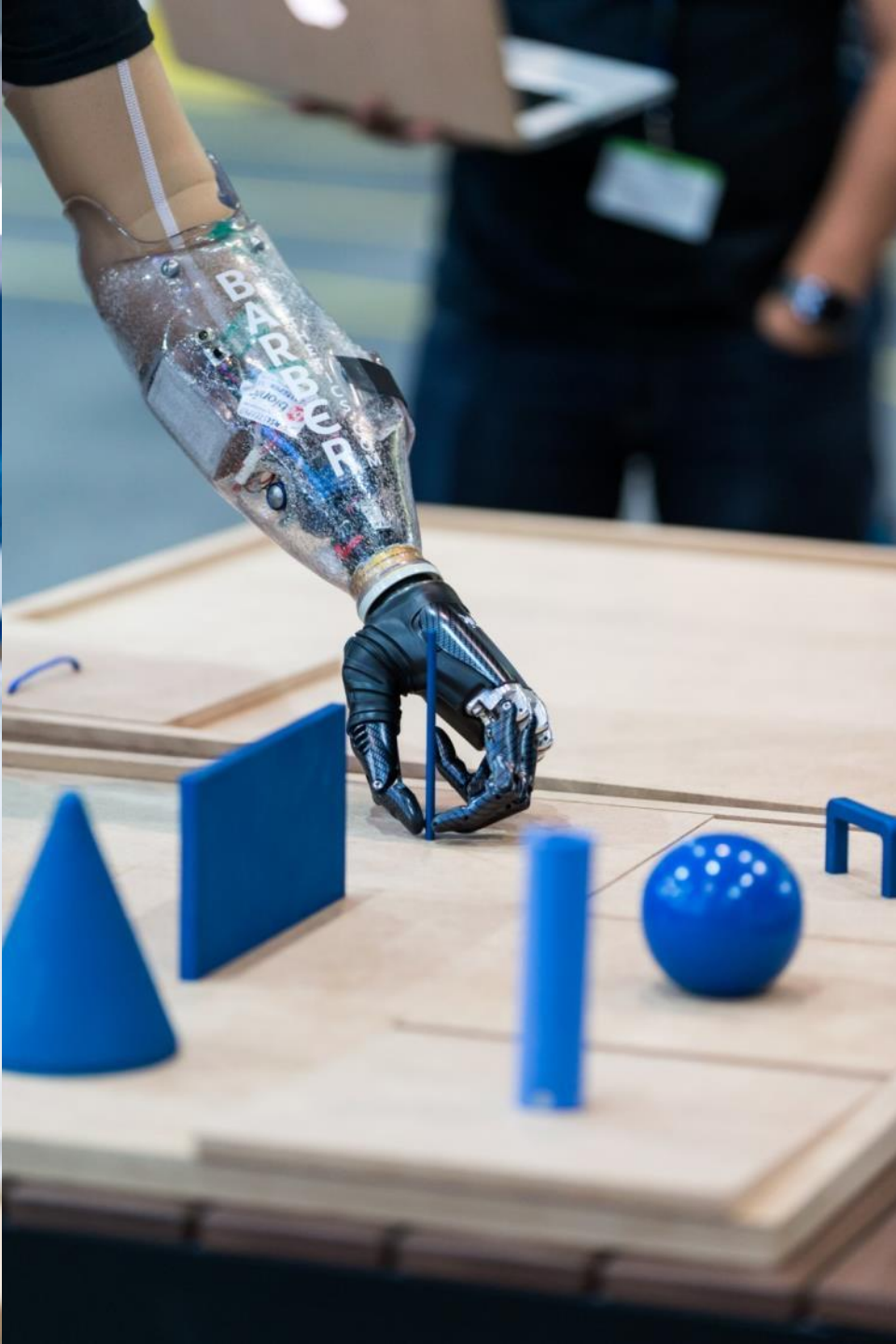



34

34

ETH Zurich  
INDUSTRY DIV 60

KROGER

ETH Zurich

ETH Zurich

ETH Zurich



0028

# Brain-Computer-Interface Race

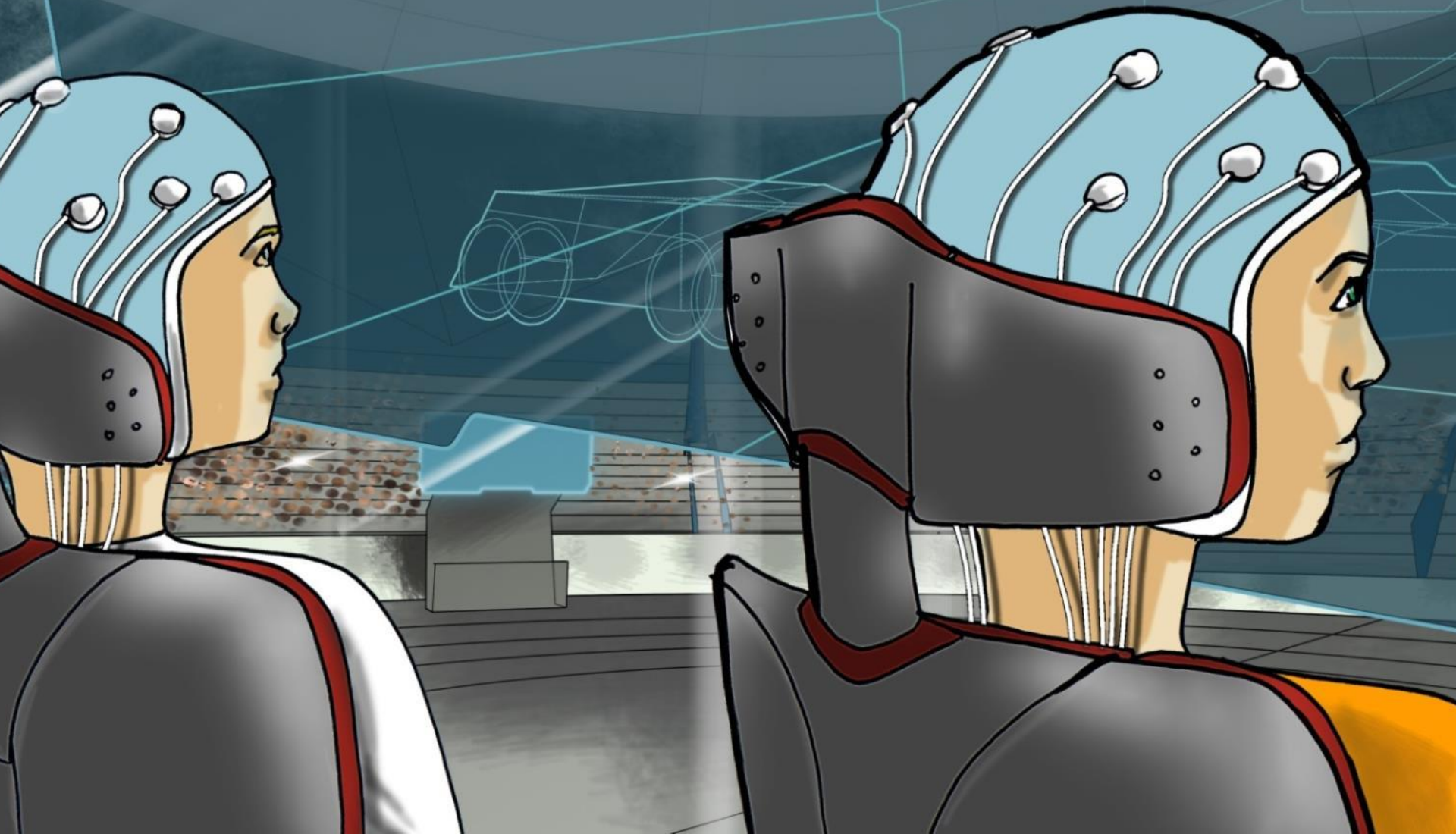





# Brain-Computer-Interface Race



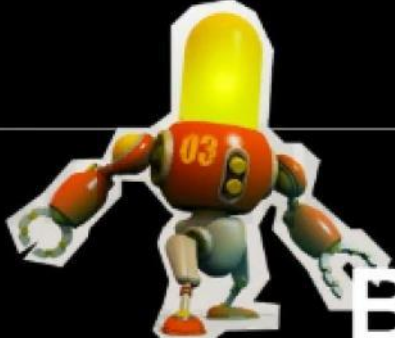

- 2. CANABAL
- 1. NEUROMANCER
- 4. WINTERMUTE

# BRAINRUNNERS

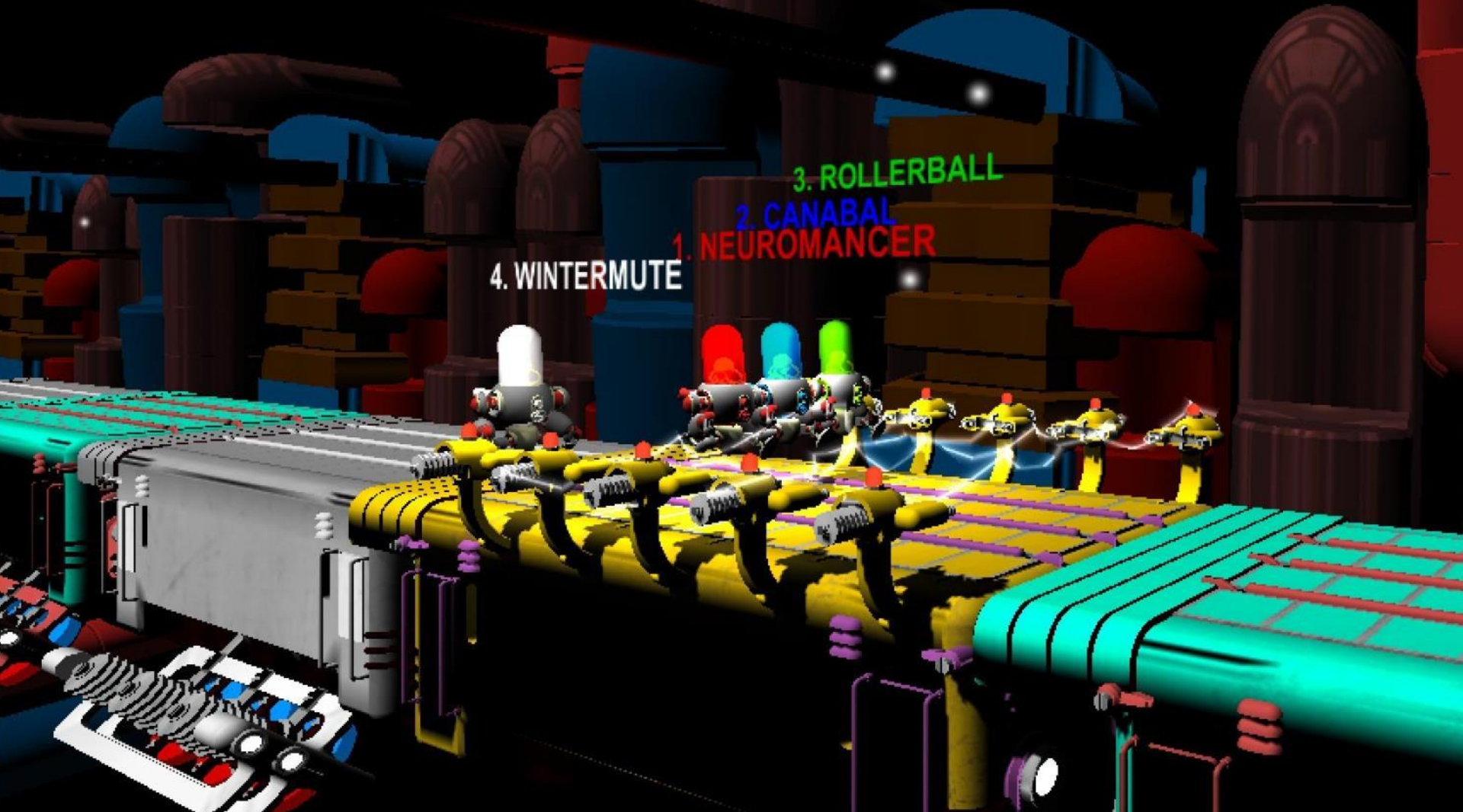

4. WINTERMUTE

- 3. ROLLERBALL
- 2. CANABAL
- 1. NEUROMANCER

Two large LED screens displaying a virtual reality racing game. The left screen shows a character in a blue and red suit racing through a tunnel, with the text "HAMMERS" and "TIME (s) 28.38". The right screen shows a character in a blue and red suit racing through a tunnel, with the text "BRAINRUNNERS" and "TIME (s) 28.38". Below the screens are two digital displays showing "3:34" and "0 | 0 G". At the bottom of each screen is the logo for "Zürcher Kantonalbank" with the text "Die nahe Bank".



A long banner along the arena floor featuring several logos and text. From left to right, the logos include "VAMED", "KICKER", "axxon motor", "Hocom", "Hoc", "MED HELP", "CYBA", "Der Balgrist", and "Central". The text "SWISS" is also visible. People are standing and working at tables in the foreground, some with laptops and equipment.







# Safety

## Remote Checks at Registration (some Months in Advance)

- Technical experts: risk analysis, movies, photos, certifications
- Medical experts: patient inclusion criteria
- Declaration of consent of team members and pilots

## Checks Right Before the Races

- Technical experts: live-tests of device technology
- Medical experts: check patient status

## Safety at the Races

- Safe tracks: max. 7 steps, handrails, cushions, helmets, helpers
- Insurances for teams, stadium, organisers





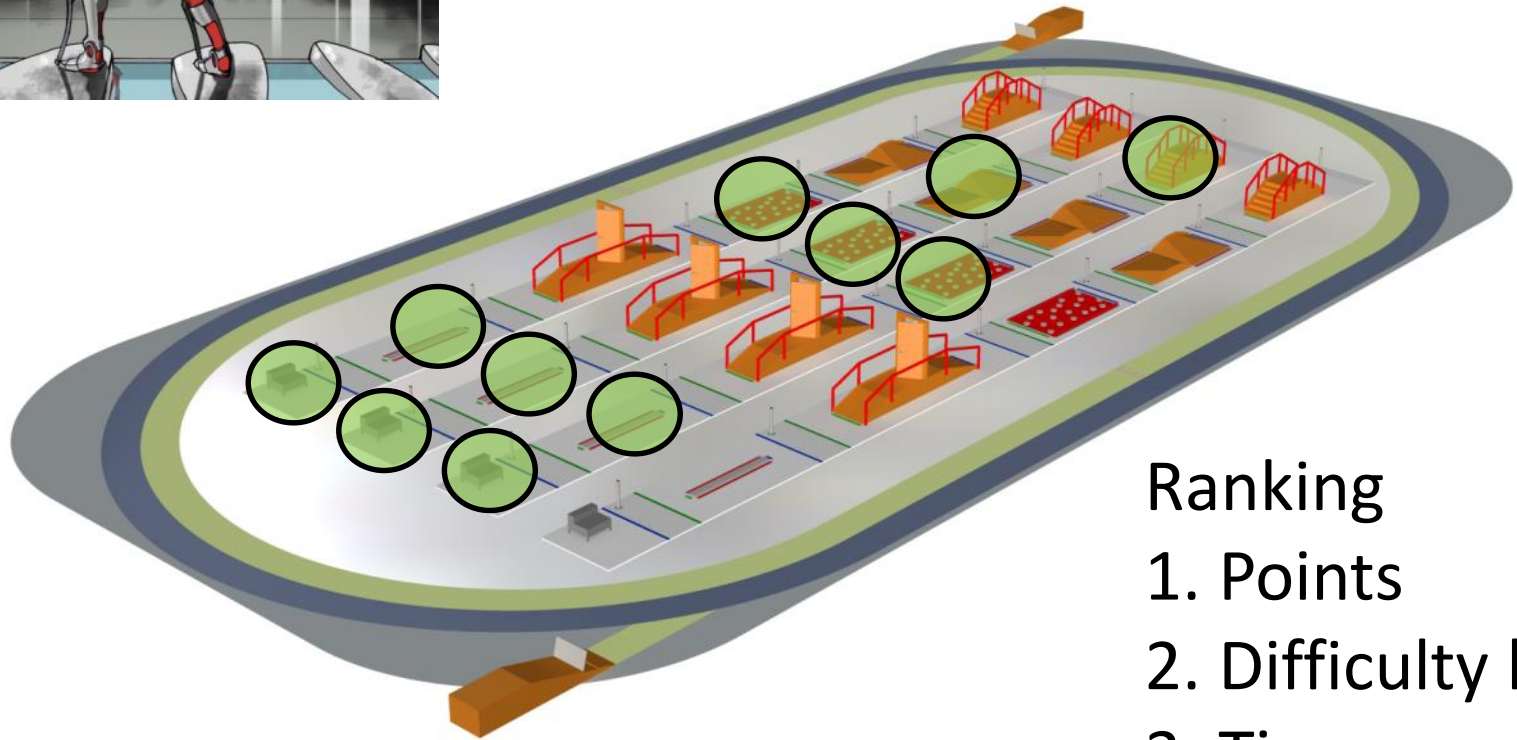
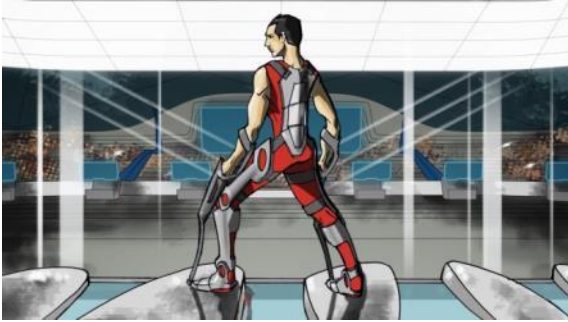

# Qualification Races



- Ranking
1. Points
  2. Difficulty level
  3. Time

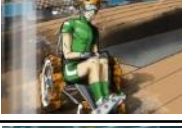

# Final Races

| Discipline   | Pilots per Race | Judging | Final Ranking                                   |   |
|--|-----------------|---------|---|---|
|  FES Bike         | 2               | Time    | <b>A-Final:</b> 🏆 🥈<br><b>B-Final:</b> 🏆 4. ... |   |
|  Leg Prosthesis   | 4               |         | Time  | <b>A-Final:</b> 🏆 🥈 🥉 4.<br><b>B-Final:</b> 5. 6. 7. 8.<br>etc. |
|  Exoskeleton      |                 |         |   |   |
|  Wheelchair      |                 |         |   |   |
|  Arm Prosthesis |                 |         |   |   |
|  BCI            |                 |         |   |   |





# Cyathlon: 8 October 2016

## QUALIFICATIONS: Morning

| Zeit  | BCI Station                | FES Bahn | Objektbahnen |
|-------|----------------------------|----------|--------------|
| 10:00 |                            |          | ARM-Q1       |
| 10:10 |                            |          | ARM-Q2       |
| 10:20 |                            |          | ARM-Q3       |
| 10:30 |                            | FES-Q1   |              |
| 10:40 | BCI-Q1                     |          |              |
| 10:50 |                            | FES-Q2   |              |
| 11:00 |                            |          | LEG-Q1       |
| 11:10 |                            |          | LEG-Q2       |
| 11:20 |                            |          | LEG-Q3       |
| 11:30 |                            | FES-Q3   |              |
| 11:40 | BCI-Q2                     |          |              |
| 11:50 |                            | FES-Q4   |              |
| 12:00 |                            |          | EXO-Q1       |
| 12:10 |                            |          | EXO-Q2       |
| 12:20 |                            |          | EXO-Q3       |
| 12:30 |                            | FES-Q5   |              |
| 12:40 | BCI-Q3                     |          |              |
| 12:50 |                            | FES-Q6   |              |
| 13:00 |                            |          | WHEEL-Q1     |
| 13:10 |                            |          | WHEEL-Q2     |
| 13:20 |                            |          | WHEEL-Q3     |
| 13:30 | <b>Begrüssung<br/>Show</b> |          |              |
| 13:40 |                            |          |              |
| 13:50 |                            |          |              |
|       |                            |          |              |

## FINALS: Afternoon

| Zeit  | BCI Station                                 | FES Bahn | Objektbahnen | Zeremonien |
|-------|---|----------|--------------|------------|
| 14:00 |   | FES-F-D  |              |            |
| 14:10 | BCI-F-B                                     |          |              |            |
| 14:20 |   | FES-F-C  |              |            |
| 14:30 |   |          | ARM-F-B      |            |
| 14:40 |   |          | ARM-F-A      |            |
| 14:50 | BCI-F-A                                     |          |              |            |
| 15:00 |   |          |              | ARM-Race   |
| 15:10 |   | FES-F-B  |              |            |
| 15:20 |   |          |              | BCI-Race   |
| 15:30 |   | FES-F-A  |              |            |
| 15:40 |   |          |              | FES-Race   |
| 15:50 |   |          | LEG-F-B      |            |
| 16:00 |   |          | LEG-F-A      |            |
| 16:10 |   |          |              | LEG-Race   |
| 16:20 |   |          | EXO-F-A      |            |
| 16:30 |   |          | EXO-F-B      |            |
| 16:40 |   |          |              | EXO-Race   |
| 16:50 |   |          | WHEEL-F-B    |            |
| 17:00 |   |          | WHEEL-F-A    |            |
| 17:10 |   |          |              | WHEEL Race |
| 17:20 | <b>Abschlussrede<br/>Show bis ca. 19.00</b> |          |              |            |
|       |   |          |              |            |
|       |   |          |              |            |
|       |   |          |              |            |

**LIVE TV**



# Benchmarking

## Standardized Safety Checks

- Device technology
- Patient inclusion & health status

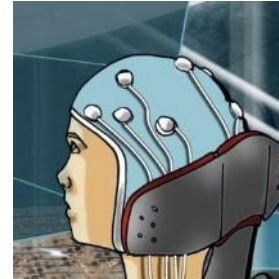

## Standardized Tracks and Obstacles

- Performance tasks
- Activities of daily living tasks

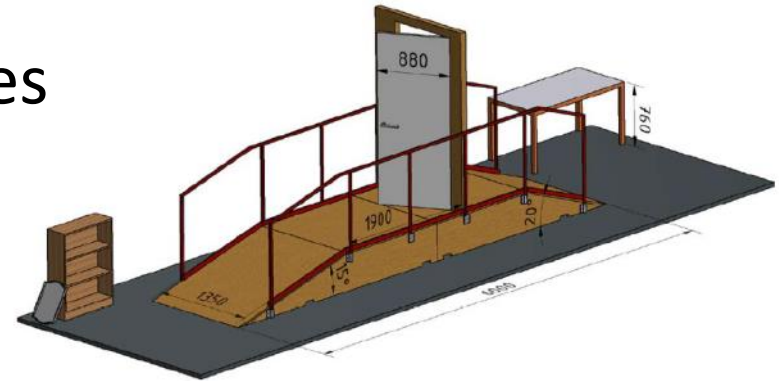

## Standardized Scoring System

- Function counts more than speed

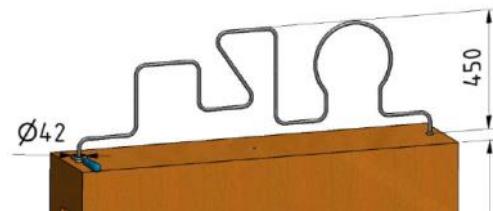



# Registrations: Current State

| Discipline   | Pilots |
|--|--------|
|  FES Bike         | 10     |
|  Leg Prosthesis   | 7      |
|  Exoskeleton      | 13     |
|  Wheelchair       | 6      |
|  Arm Prosthesis | 8      |
|  BCI            | 14     |

## Actual State (Sept '15)

- 58 Pilots
- 50 Teams
- 22 Countries pilots:
  - Europe 40 (Swiss 9, UK 9)
  - North America 7
  - Latin America 3
  - Asia 7
  - Australia 1



# Organisator, Sponsors, Partners

## Organisator

**ETH**

Eidgenössische Technische Hochschule Zürich  
Swiss Federal Institute of Technology Zurich

## Presenting Sponsor

robotics<sup>+</sup>

Swiss National  
Centre of Competence  
in Research

## Main Sponsors

Der **Balgrist**

Wir bringen Energie



 **Hocoma**

  
**VAMED**  
health. care. vitality.

## Premium Partners

  
**DENK AN MICH**  
Ferien und Freizeit für Behinderte

**MBF**  
*foundation*

 **Cerebral**  
Schweizerische Stiftung für das cerebral gelähmte Kind

 **MS**  
Schweizerische  
Multiple Sklerose  
Gesellschaft



side the "Cybathlon" and future robotics



**ROBERT RIENER**  
Cybathlon Organizer

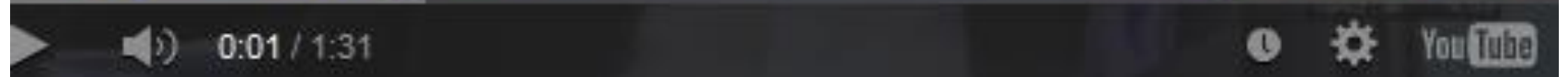



**BBC** News Sport Weather Capital Future Shop

# NEWS TECHNOLOGY

Home UK Africa Asia Australia Europe Latin America Mid-East US & Canada Business Health

27 March 2014 Last updated at 12:24 GMT



## Bionic Olympics to be hosted in 2016

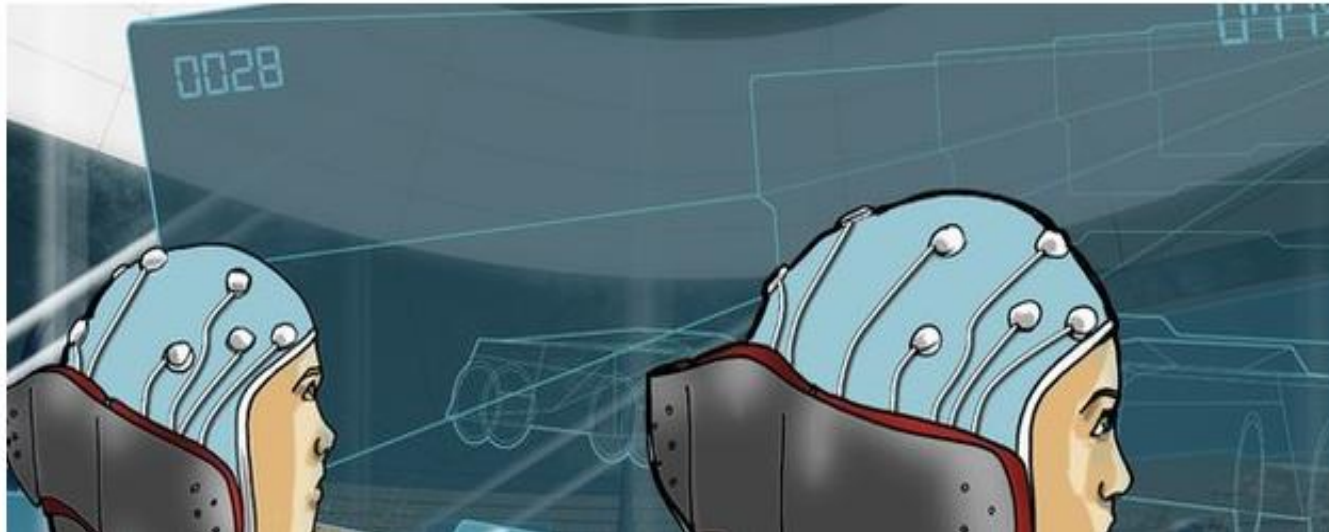



RADIO-CANADA

la Repubblica



Neue Zürcher Zeitung



INTERNATIONAL  
BUSINESS TIMES



The  INDEPENDENT





# Japanese Television Shows



NHK Sakidori, June 2015



NHK News Channel, Oct 2014



# The Cybathlon

8 October 2016

**See you there!**

