

LOW-COST, HIGH PERFORMANCE SERVO-PNEUMATIC MANIPULATORS WITH SENSOR FEEDBACK

A. de ALMEIDA, H. FACHADA, J. DIAS, P. AMADO, P. MENEZES, U. NUNES

Departamento de Engenharia Electrotécnica,
Universidade de Coimbra,
Largo Marques de Pombal,
3000 COIMBRA, Portugal

Abstract-To increase the penetration of industrial robots there is a need for inexpensive and flexible manipulators. This paper describes a low-cost manipulator which uses pneumatic cylinders as the actuators. The cylinders do not require any gearboxes and are fitted with incremental encoders for continuous position monitoring. Continuous positioning of the manipulator axes is achieved through proportional pneumatic valves driven by a hierarchical control structure. This distributed structure also simplifies the integration of the sensors required for each particular application. A machine vision system based on the use of fast digital signal processors was developed, providing additional sensory feedback.

Introduction

Most industrial robots are fairly expensive due to the use of precision components such as harmonic drives, accurate gearboxes, servomotors and encoders. High repeatability and precision is normally required in robot cells due to the low-level of sensor information generally available. As lower cost and more flexible sensors become available it may be possible to design manipulators performing in a way similar to a human operator. The human arms have fairly low repeatability but with sensory feedback (mainly vision and touch) they are able to perform demanding tasks both in terms of precision and flexibility. When the work performed in assembling a mechanical wrist watch is considered, human hands are able to achieve an accuracy hundreds of times better than without sensory feedback.

The work described aims at developing a low-cost medium precision manipulator whose performance is highly enhanced by sensory feedback. To achieve low cost, pneumatic actuators are used. The manipulator is of the cartesian type with two rotating degrees of freedom in the wrist, having a load capability of 2Kg.

Traditionally pneumatic actuators could not be used for continuous positioning due to the compressibility of the air and due to the complex control required. In this case inexpensive rotary encoders are coupled to the moving rods of the pneumatic actuators, proportional valves are used to control the pressure on both sides of the pistons and thus the actuating force of the actuator. The position control of the actuators is made difficult by the hysteresis of the proportional valves, the non-linear friction of the pistons in the cylinders and the compressibility of the air.

Each pneumatic actuator has associated its dedicated controller. Each controller consists of a card with an inexpensive and powerful single-chip microcomputer, program ROM memory, data RAM memory and communication capabilities (local parallel bus and a high-speed serial interface). Additionally the rotary encoder and proximity switches interfaces, as well as the pulse-width modulation circuit to control each proportional valve are built in another card sharing the same local parallel bus with the main card. A master control unit (type IBM/AT with a numeric coprocessor) controls each individual axis through the

serial interface.

The software algorithms developed around two well-known control methods, variable structure control [1], [2] and proportional-integral-derivative control [3], are being tuned for optimal performance. To overcome the problems of hysteresis of the proportional valves and friction of the pistons an alternated component is injected in the windings of the valves superposed on the main command signal. In the vertical axis, whose load is considerable, to avoid jittering associated with the compressibility of the air a pneumatic brake is used to lock the moving rod. This brake consists of two miniature cylinders which lock the rod when the desired position is obtained.

A machine vision system based on the use of fast digital signal processors, was also developed. This system is based on a VMEbus host computer, a frame grabber and several image processing units which can be connected in a parallel-processor architecture allowing different time requirements to be satisfied.

Mechanical robot structure

The mechanical architecture of the manipulator was designed taking into account that its first use is intended to be on a plastic molded injection environment. Molded pieces picking, jitter cutting and storing are some of the operations to be performed.

The manipulator is of the cartesian type with three linear degrees of freedom and with two rotating degrees in the wrist. Fig.1 shows, in a schematic form, the mechanical structure of the manipulator, and in the Fig.2 is represented its geometrical model. Over the fixed plate of the injection machine is placed transversally the mechanical support of the overall manipulator corresponding to one axis. Over this support travels a guided car which includes the two remaining linear axis. The manipulator is equipped with a wrist with two rotating joints geometrically disposed as shown in Fig.2.

Distributed robot system architecture

The robot system under development exhibits a hierarchical control structure of the form illustrated in Fig.3. A high-speed serial network in a bus topology and with a hierarchical structure, BitBus interconnect [4], is used to perform the integration of all the subsystems. This network is materially implemented in hardware through an enhanced version of the 8051 microcontroller, referenced 8044, and in software through a real-time multi-tasking executive in conjunction with some specific BitBus utilities. Since BitBus was optimized for fast transfers of small packets of information it is suitable to be used in a wide spectrum of local control applications, particularly at the sensor and actuator level. Due to the characteristics already mentioned and due to its low implementation cost, it was chosen to interconnect all subsystems.

A set of tools at both levels, hardware and

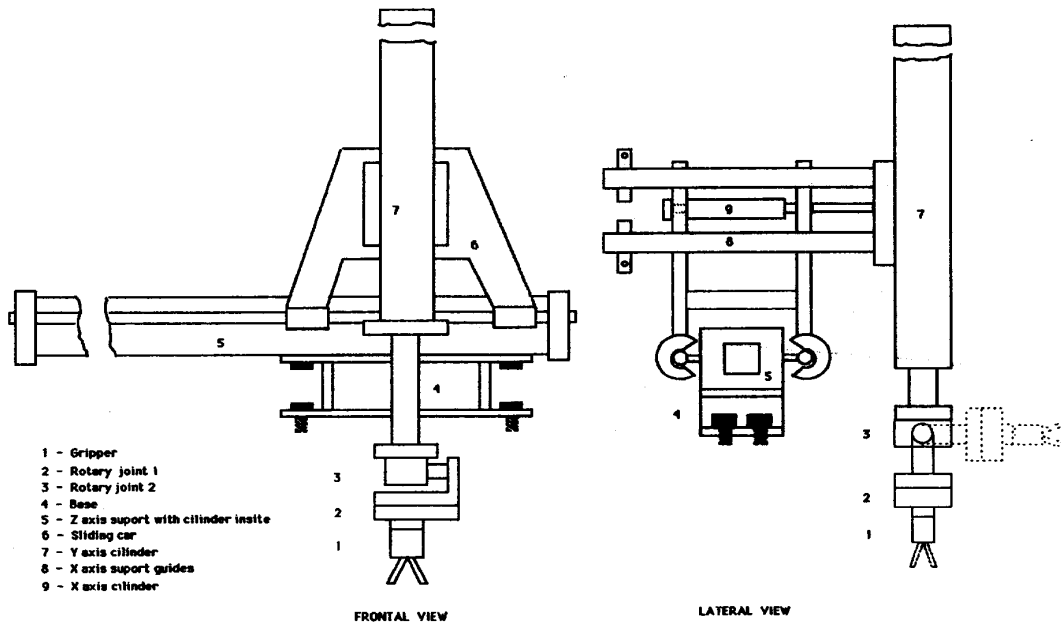

Fig 1. Mechanical robot structure.

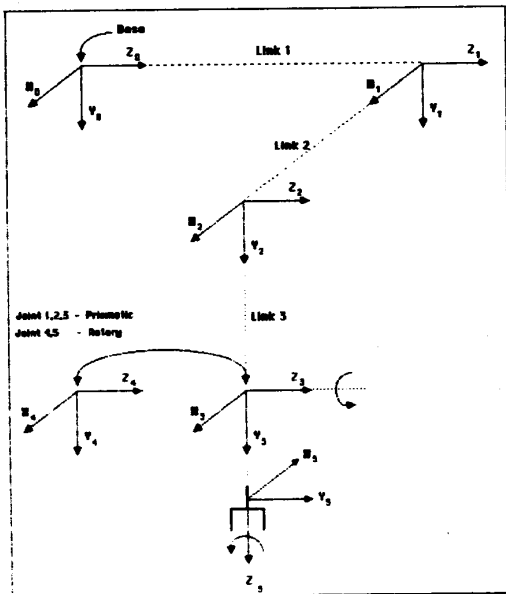

Fig.2. Manipulator geometric configuration.

software, was designed being most of them already developed and others being under development following basic concepts such as: modularity and real-time capability. The modular configuration, based on multi-microcontrollers subsystems, makes easy the job to endow the overall application system with requirements such as: reconfigurability and expansibility. At the software level requirements are taking into account concerned not only with the real-time processing capability but also with safety, versatility (associated with the integration of sensorial data) and an easy interface with user. Several applications can be developed based on the integration of these tools such as the flexible robot system object of this paper. This approach as shown in Fig.3 integrates a master system, designated supervisor controller, and three subsystems with distinct responsibilities: manipulator and gripper controller, real-time image processing and other external sensor and actuator units.

Manipulator and gripper controller

This subsystem, besides its applicability in a general sensor-based system, can be applied on a self-contained context to perform many simple and repetitive manufacturing operations. The block diagram of the Fig.4 illustrates the configuration of this controller. Its minimum configuration consists of a manipulator supervisor and five single-joint controllers, being three for the linear axis and the remainders for the two rotating movements of the wrist, all of them also interconnected on a BitBus architecture.

The manipulator supervisor is set up by an IBM/AT equipped with two modules dedicated to the communications. One of them, connected to the high-level BitBus channel, acts as a slave and the other acts on a master context in relation to the single-joint and gripper controllers.

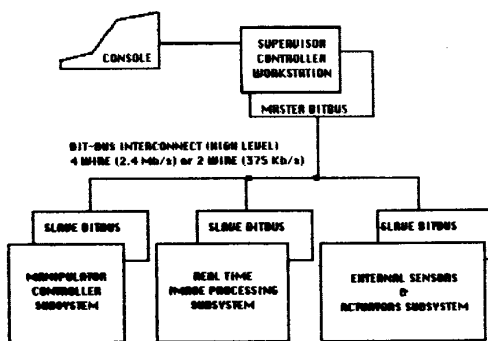

Fig. 3. Distributed robot system.

structure; optical encoder input; direction discriminator with position detector and finally an interface to the local parallel bus.

For manual operation there are a dedicated controller, connected to the serial network, implemented with a local BitBus board.

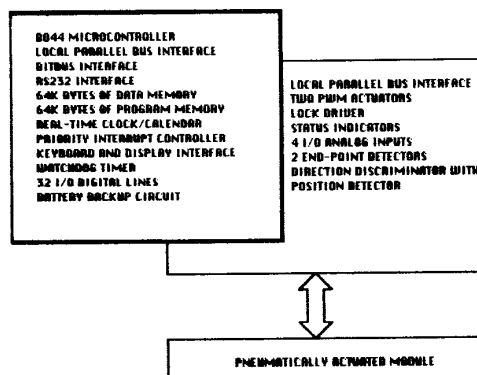

Fig. 5. Single-joint controller.

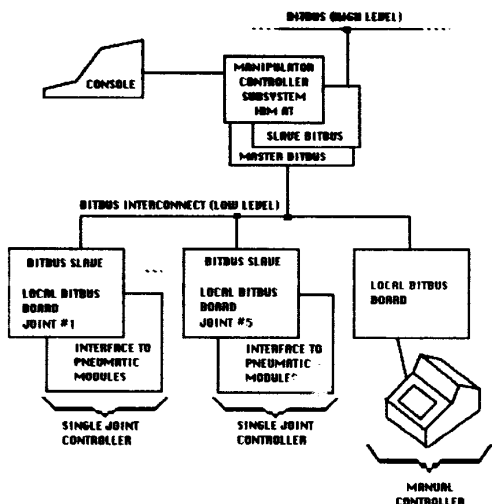

Fig. 4. Manipulator controller.

Each single-joint controller is composed by two boards with the functions described on Fig. 5. One is a general purpose board, henceforth designated local BitBus board, which mainly includes: an interface to a local parallel bus; a RS232 serial interface; a BitBus interface with different selectable modes of operation (with different options for data transfer rates versus maximum distance); a 8044 microcontroller; up to 64 Kbytes of both external data and program memory organized in a flexible mode with four physical spaces; real-time programmable clock-calendar; a priority interrupt controller for eight different lines; optional keyboard and display interface circuits; 32 TTL level I/O lines; watchdog timer and battery back-up circuit. The other board, interface to pneumatic module, has the circuits to interface with the pneumatically actuated modules namely: two PWM actuators; lock driver; status indicators; four input channels multiplexed to a single A/D converter; two end-point detectors actuating in the interrupt

Real-Time Image Processing

A vision system was developed for image processing in the fields of robotics and product inspection [5]. In this application this system works as an intelligent sensor. Working under the control of a host computer, the vision system, in its minimum configuration, is composed of two boards - a video acquisition display and transmission unit and an intelligent image processing unit - which are capable of handling images with 512x512 pixels with 256 grey levels per pixel.

The vision system (see the schematic of Fig. 6), including a general purpose digital signal processor in the image processing units, allows the construction of a serial-instruction-multiple-data (SIMD) structure suitable for this type of processing without compromising flexibility. On the other hand, the modular approach taken in the design of the system, permits its adaptation to particular applications.

The video acquisition display and transmission board is a self-contained unit interfacing this system to standard black and white TV cameras using the CCIR norm and to conventional black and white or colour monitors. Up to four video inputs can be connected to the acquisition board which uses a flash 8-bit analog to digital converter to digitize the selected channel.

The acquisition board has the capability of storing two complete images of 512x512 pixels on its internal 512K bytes of RAM memory organized as two 256K bytes frame buffers - a useful facility during developing and testing stages to compare raw and processed images. Although the video memory is accessible by the CPU on a pixel basis, allowing image processing by the host, this is not the normal working situation. In fact a major feature of the board is the capability of transmitting, through a secondary bus, the digitized video which becomes available to the intelligent image processing boards that are connected to the system. The video bus, which is constructed around uncommitted pins of the VMEbus P2 socket, has a very simple unidirectional structure since it carries the incoming camera picture in a usable form for the processing units.

Each of the intelligent image processing boards used in the vision system consists of four parts: a

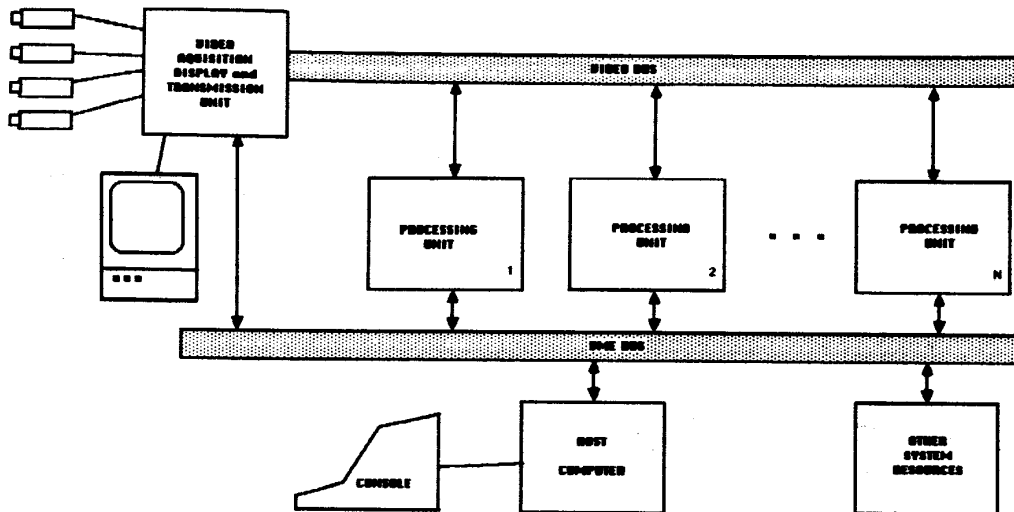

Fig.6. Vision system.

video input module, a TMS32020 microprocessor, a local memory and a VMEbus interface. The video input module uses both the data and the addresses appearing on the video bus to place an image, or a part of it, in memory. Under the command of the host computer the video input module may be configured to acquire images of different sizes (windows) and different resolutions. The 16-bit TMS32020 processor with its 200ns instruction cycle and its data address space of 64K words was chosen for this application. The intelligence of the board is only local and the DSP processor is totally controlled by the VME host computer. In fact all the memory of the DSP processor, both program memory and data or video memory, is RAM and appears in the address map of the host which, for example, may halt the DSP processor, download a program or a command, activate the reception of a picture through the video bus and return control to the DSP processor for execution of the command.

This intelligent board can store and process a complete 8-bit 512x512 image, i.e. 256K pixels. This video information is physically organized as 128K words originating two pixels transfers per access. For the DSP processor it is logically organized as 256K bytes in eight pages of 32K bytes with only one of these pages being present at a time on the top half of the DSP memory referred to above. Note that when the TMS32020 addresses the video data on the top of the memory, it only finds 8-bit bytes in each location instead of the usual 16-bit word. This is adequate for pixel data processing. The host computer has the responsibility of halting the DSP processor before making an access to the video memory, avoiding in this way any conflict in the access to the shared memory. The VME interface module of the processing board permits the access to the video memory, the access to the TMS32020 program memory, the control of the video interface module and the control of a number of registers to operate the board.

Other External Sensors and Actuators

The inclusion of sensorial data in the robot-based systems can increase substantially the scope of

applications of the robots in industry. With this information many of the difficulties of uncertain circumstances can be positively handled. For these applications were developed specific cards for analog acquisition and actuation which in conjunction with a local bitbus board built up dedicated sensorial preprocessors units. In this way many types of sensors and peripheral equipment can be used cooperatively to endow the robot system to perform complex assembling tasks.

Pneumatic Joint, Actuator and Control

Traditionally pneumatic actuators could not be used for continuous positioning due the compressibility of the air and the nonlinear friction effects. With these constrains it is extremely difficult to model the pneumatic actuator, and complex strategies of control are required [6]. In this work we aim to overcome these difficulties using two well-known control algorithms without loosing too much on precision and accuracy. For this purpose we are using proportional valves, which provides basically a change of air flowrate of the actuator in proportion to the change in electrical current to the proportional solenoid, incremental rotary encoders which are coupled to the moving rods of the pneumatic actuators and an electro-pneumatic lock to prevent motion in the rest state [7].

The joint control is being developed around the following well-known control concepts: variable structure control (VSC) and proportional-integral-derivative (PID).

The VSC method applied in the pneumatic actuator is based on the VSC-based position-control experiment described in [1]. Due to its great insensitivity to parameter change it can be applied to overcome the non-linear effects inherent in pneumatic systems. The main problem in this approach is to reach optimal structure coefficients. Since the results obtained are satisfactory more trials are being made to tune those coefficients and at last to improve the system's response. The slope of the switching line is also under analyse. Fig.8 shows a yet satisfactory system

response with the corresponding control signal.

The VSC method is intended to be applied by itself in short distance movements as well as in connexion with a PID based algorithm in the remaining movements. The PID control is used, out of the VSC positioning band, to achieve a better system speed response. The PID controller coefficients are being tuned for optimal system response.

To overcome the problems of hysteresis of the proportional valves and friction of the pistons an alternate component is injected in the windings of the valves superposed on the main command signal.

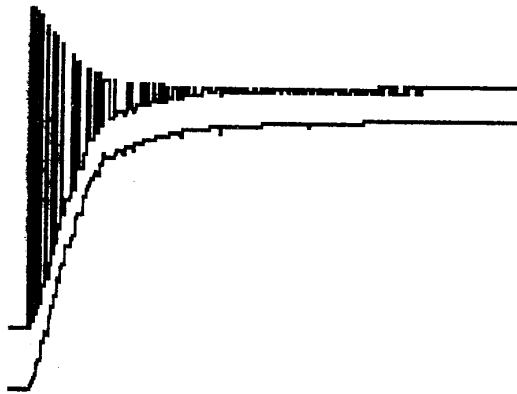

Fig.8. Control signal (upper) and system response (bottom).

Manipulator Control

The main goal of the manipulator control is to maintain the motion of the arm along a predefined trajectory. In this work this control is structured at the Cartesian level, being the position of the joints the variable under control. Handling each joint separately and neglecting the motion and configuration of the whole arm mechanism have the result of a reduced speed and limited precision, making this strategy appropriate only for medium-precision tasks. In fact, this manipulator is firstly designed for material handling in the plastic industry.

The environment can include the manipulator, objects to be assembled, peripheral equipment (conveyor, assembly table, etc) and obstacles to be avoided. The use of suitable sensors to gather information about the environment allows the manipulator to perform automatic operations with a certain degree of complexity. However this requires the processing and the integration of a substantial amount of sensorial data which must be performed in real-time. The control strategy must be carefully specified and could be highly enhanced by an elaborated computer structure whose enables an effective sensory feedback. Hierarchical sensor-based control structures and many other concepts have been suggested [8], [9], [10] which facilitate the development of structured multi-sensor systems.

Within such an environment the execution of a task by the manipulator generically comprises three different phases including target search, movement between work position and close-range manipulation. These phases are characterized by using different types of sensor information.

In the phase of target search the role of vision sensors is dominant. Vision information may be complemented by range sensors (such as ultrasonic or laser). With the information obtained with the vision

system it is possible to identify roughly the positions of the parts to be manipulated, and thus to carry out the planning of the next phase. The phase of movement between work positions consists in manipulator gross motions and the positioning of the peripheral equipment. In the close-range manipulation phase, it is performed the final approach to the parts to be handled including the accurate positioning and the actuation of the gripper. The sensors which play an important role in this phase are the proximity, tactile and force sensors.

The overall manipulator control, which is being designed is logically organized in three hierarchical structured levels: task level, action level and supervision level.

The task level makes the interface with the user, receiving high-level task descriptions and visualizing information related with the state of the cell, generates actions plans and processes failure analysis. The action level manages the cell operations activating supervisor level procedures, sending commands and receiving sensing information and asynchronous events. The low level is composed by a set of environment dependent procedures which handles, through the local controllers, the cell actuators and sensors.

Conclusion

New types of manipulators featuring both low-cost and flexibility are required to expand the spectrum of applications in factory automation, namely for assembly purposes. A pneumatic manipulator with continuous positioning control and making use of inexpensive air cylinders for direct actuation, is being developed with promising results. To overcome the problems associated with the highly non-linear nature of the system composed by the proportional valves and the pneumatic cylinders, both variable structure control algorithms and proportional-integral-derivative algorithms are used to achieve an optimal response. In order to investigate the dynamics behaviour of the proportional valves and the cylinders, differential pressure solid-state transducers are going to be installed in the cylinders.

The hierarchical distributed control structure besides enabling efficient communication between the master controller and the individual axis, also allows the integration of distributed sensors required for a particular application.

References

- [1] N.N.Bengiamin and B.Kauffmann, "Variable structure position control," IEEE Control systems magazine, Aug.1984, pp.3-8.
- [2] J.J.Slotine, "Robust control of robot manipulators." Int.J.Robotics Res., vol.4, no.2, 1985.
- [3] J.H.Aylor, et al., "Design and application of a microprocessor PID predictor controller," IEEE Trans., vol.IECI-27,no.3, Aug.1980., pp.133-137.
- [4] Intel Corporation, "The BitBus interconnect serial control bus specification," in Distributed Control Modules Databook, pp.100-147, 1984.
- [5] A.de Almeida, et al., "A digital signal processor based vision system," NATO ARW on Real Time Sensing in Robotic Systems, Italy, sept.1987.
- [6] C.A.Czarnecki and D.R.Towill, "Dynamic modelling of a three-axis pneumatic robot," in Trans. of the Institute of Measurement and Control, vol.10, no.1, Jan-March 1988, pp.50-56.
- [7] R.H.Weston and G.Morgan, "A new family of robot modules and their industrial application," IMechE, C461/84, 1984, pp.51-57.

- [8] J.S.Albus, et al., "Hierarchical control for sensory interactive robots," in Proc.11th Int.Symp. Ind.Robots, SME and RIA, Oct.1981, pp.497-505.
- [9] T.C.Henderson and E.Shilcrat, "Logical sensor systems," in Journal of Robotic Systems, 1984, pp.163-193.
- [10] G.Hirzinger, "Robot systems completely based on sensory feedback," IEEE Trans.Ind.Elect., vol.IE-33, no.2, May 1986, pp105-110.